

TECHNICAL AND OPERATIONAL DOCUMENTATION
INSTALLATION MANUAL,
OPERATING MANUAL AND INSTRUCTIONS FOR SAFE USE

(Translated from the original manual)

- 11. Awnings
- 11.5 Terrace awning **PALLADIO**



PRODUCT NAME:

- TERRACE AWNING
PALLADIO

PRODUCT MANUFACTURER'S MARKING:

- Manufacturer's name:
SELT Sp. z o. o.
- Manufacturer's registered office:
45- 449 Opole, ul. Wschodnia 23A
- Contact details:
Tel: +48 77 553 21 00 (secretariat)
Fax: +48 77 553 22 00
- Website:
www.selt.com
- E-mail:
selt@selt.com

PRODUCT SAFETY MARKING:

The product meets the CE safety requirements.

THIS TECHNICAL AND OPERATIONAL DOCUMENTATION:

- Is valid from: 28 March 2022
- Is applicable to the above listed product versions.

TABLE OF CONTENTS

TABLE OF CONTENTS	3
1 INTRODUCTION.....	4
1.1 SAFETY GUIDELINES FOR THE PRODUCT	4
1.2 EXPLANATION OF SYMBOLS AND SIGNS	4
1.3 TERMS AND DEFINITIONS	5
1.4 SUBJECT, INTENDED USE AND CONTENTS OF THE DOCUMENTATION	5
2 PRODUCT TECHNICAL INFORMATION.....	6
2.1 TECHNICAL PARAMETERS	6
2.2 PRODUCT SPECIFICATION	6
2.3 PALLADIO AWNING CONSTRUCTION	7
2.4 TYPE OF BRACKETS.....	7
3 TRANSPORT AND STORAGE OF THE PRODUCT	8
3.1 COMPLETENESS AND QUALITY CONDITION OF DELIVERY	8
3.2 GENERAL CONDITIONS FOR TRANSPORT AND STORAGE OF THE PRODUCT	8
3.3 OBLIGATORY DESCRIPTIONS TO BE PLACED ON THE PRODUCT PACKAGING	8
4 PRODUCT INSTALLATION	9
4.1 REQUIREMENTS FOR SAFE INSTALLATION OF THE PRODUCT AT HEIGHTS.....	9
4.2 PREPARATION FOR INSTALLATION.....	10
4.3 GENERAL REQUIREMENTS FOR SAFE INSTALLATION	10
4.4 INSTALLATION TOOLS	10
4.5 INSTALLATION	10
4.5.1 PALLADIO AWNING INSTALLATION –WALL BRACKETS.....	10
4.5.2 PALLADIO AWNING INSTALLATION – CEILING BRACKET	14
4.5.3 PALLADIO AWNING INSTALLATION – ROOF RAFTER BRACKET.....	14
4.6 ELECTRIC DRIVE.....	14
4.6.1 CONNECTION TO ELECTRICAL INSTALLATION	14
4.6.2 REMOTE OPERATION.....	15
4.6.3 START-UP AND ADJUSTMENT.....	15
4.7 MANUAL DRIVE	16
5 SYSTEM OPERATION AND PRODUCT SAFETY.....	17
5.1 GENERAL REQUIREMENTS FOR OCCUPATIONAL HEALTH AND SAFETY	17
5.2 SAFETY REQUIREMENTS RELATED TO SPECIAL CONDITIONS AND PLACES OF PRODUCT USE.....	17
5.3 OPERATIONAL SAFETY.....	17
5.4 CONTROL OF SAFE USE OF THE PRODUCT	19
6 SYSTEM USE AND MAINTENANCE	20
6.1 USING THE PRODUCT IN ACCORDANCE WITH ITS INTENDED USE	20
6.2 INSTRUCTION FOR NON-PROFESSIONALS.....	20
6.3 TECHNICAL INSPECTIONS, MAINTENANCE AND REPAIR	20
6.4 USE OF AWNING FABRICS	21
7 GENERAL WARRANTY TERMS	23
7.1 WARRANTY EXCLUSIONS	23
8 COMPLAINT / TECHNICAL DEFECTS	25
8.1 COMPLAINTS.....	25
8.2 TECHNICAL DEFECTS	25
9 PRODUCT DISASSEMBLY / UTILISATION / DISPOSAL.....	26
10 MARKING AND LABELLING OF THE PRODUCT WITH CE MARK	27
10.1 PRODUCT COMPLIANCE WITH THE CE STANDARD	27
10.2 INFORMATION ACCOMPANYING THE CE MARKING	27

1 INTRODUCTION

1.1 SAFETY GUIDELINES FOR THE PRODUCT

The product has been manufactured in accordance with the latest technical knowledge in the field of construction and manufacturing and meets the safety requirements in accordance with the following standards.







The safe construction of the product was achieved thanks to:

No.	Subject	European legal basis	Polish legal basis
1	External blinds. Performance requirements including safety	EN 13561:2015	PN-EN 13561:2015
2	Construction Products Regulation (CPR)	Regulation (EU) no 305/2011 of the European Parliament and of the Council	Act of April 16, 2004 on building products DZ. U [Journal of Laws] 2004, No. 92, item 881 as amended of (Dz.U. [Journal of Laws] 2016.1570; 2015.1165; 2016.542)
3	Essential requirements for machines	Directive 2006/42/EC of the European Parliament and the Council	Resolution of the Minister of Economy of 21 October 2008 DZ.U. [Journal of Laws] 2008 No. 199 item 1228) 1228 as amended (Dz.U. Journal of Laws 2011.124)

Related documents: Declaration of Performance, Declaration of Conformity (only products with motor) and instructions for installation, use of motors and control.

1.2 EXPLANATION OF SYMBOLS AND SIGNS

The following symbols (pictograms) indicate particularly important threats and safety information.

Pictogram	Pictogram meaning	Information
	INFORMATION	Prior to using the product, its operating manual should be read. Following the operating manual guarantees: - failure-free use of the product, - warranty coverage against product defects Keep the operating manual for safety of people.
	INFORMATION	No harmful or dangerous consequences for people or facilities.
	NOTE!	A situation likely to cause product damage or other damage. No threat for people.
	WARNING!	Threat of danger
	DANGER!	This symbol marks all safety information which, if not observed, could endanger the life or health of persons. Health or life hazard. Risk: danger of serious injury or death. Unsafe operation that may cause injury or damage to the product.
	WARNING!	Threat to human life or health due to electric shock.
	ENVIRONMENT	Marking of electronic or electric equipment, which should be collected in the designated points.

1.3 TERMS AND DEFINITIONS

For the purposes of this documentation the following terms and definitions shall apply:

AWNING: Terrace awnings, as external sun protection screens are installed solely on the outside of the building for protection from sun light for terraces, restaurant patios, balconies, shop windows etc. Rolling up and down of the awning fabric is performed with the use of an electric control mechanism or manual crank.

AWNING FABRIC: Part of the product serving for protection from sun light, but also having a decorative function. Manufactured from high quality materials is put into motion with manual or electric control mechanism, assuring the product fulfills its function.

1.4 SUBJECT, INTENDED USE AND CONTENTS OF THE DOCUMENTATION

This documentation covers the products manufactured by SELT Sp. z o.o.
This documentation applies to all types of terrace awning Palladio.



User's manual and instructions for safe use, with motor manual, should be handed over to the end user.

IMPORTANT INSTRUCTION RELATED TO SAFETY
WARNING - IT IS VERY IMPORTANT TO PROCEED ACCORDING TO THIS MANUAL
TO ENSURE PEOPLE SAFETY.
KEEP THIS MANUAL



The documentation is valid jointly with the information concerning a specific product, which is available on the website www.selt.com

This documentation includes:

- important recommendations concerning product installation, use and maintenance.
- important recommendations concerning product transport and storage.
- tips following which will assure long-time and fault-free use of the product.

SELT SP. Z O.O. shall not bear responsibility for damage resulting from failure to follow recommendations included in the documentation.

In order to further improve the product, SELT SP. Z O.O. reserves the right to introduce changes which, while maintaining the essential technical parameters, shall be deemed purposeful for improving product operation quality and safety of use.

SELT SP. Z O.O. with a head office in Opole shall hold the copyrights to this documentation. The documentation cannot be used without permission, either partially or as a whole, for any concurrent business activity nor can it be made available to third parties.

2 PRODUCT TECHNICAL INFORMATION

Technical specifications of the product are available after logging in on website www.selt.com

2.1 TECHNICAL PARAMETERS

TERRACE AWNING PALLADIO	
Projection:	1,6 m, 2,1 m, 2,6 m, 3,1 m 3,6 m*
Maximum projection	3,6 m
Minimum width	Projection + 0,5 m or with overlapping arms: projection – 0,4 m
Maximum width	7,0 m
Roller tube diameter	70 mm
Arms*	Folding, aluminium, with springs and Flyer's chain, folded arms levelling
Tilt angle	5° - 50°
Optional hood	No
Manual drive	Crank 1,5 m; 1,8 m; 2,2 m
Electric drive	Motor, motor with emergency override, remote control receiver, weather sun-wind automation
Construction colour	White, beige, brown, silver, structural graphite
Fabric	c. 150 patterns
Valance**	3 shapes according to the template – shape modulus of D and C variable due to different system widths; standard height 21 (± 0,5cm), max. non-standard height 40 (± 0,5cm) or straight 50 (± 0,5cm)
Application	External
Mounting brackets	Wall, ceiling, roof rafter

* the overlapping arm option is not available with a projection of 360 cm

** - in the case of a non-standard valance over 21 cm, there is a likelihood of abrasions / damages related to its longer length (e.g. abrasions against the facade, greater susceptibility to wind blows, etc.)
- in type C and D valances, depending on their width and type of fabric, the technology may cause the lack of the "wave" effect at its ends.



The tolerance of the dimensions of the awning width is ± 2 cm

Due to technological reasons, slight differences in colour shade are deemed acceptable and they are not a ground for complaint.

Detailed data on the parameters of individual motors are available on the websites of motor manufacturers and on the website:

www.selt.com → OUR OFFER → MOTOR,
ELECTRIC,
EQUIPMENT



The optional use of weather automation additionally protects the product against changing weather conditions.

2.2 PRODUCT SPECIFICATION

Products manufactured by SELT Sp. z o. o. have appropriate technical and operational parameters.

They have the following features:

- They provide excellent sun protection for surfaces such as terraces and balconies.
- They protect against intense solar radiation.
- They are aesthetic and durable structures.
- Thanks to the simple construction and solid realization, they are used in commercial areas.
- The motors have an IP 44 degree of protection, which means that they are protected against water splashing onto the casing from any direction.

- Increased functionality thanks to the use of wind and solar automation and radio control.
- Awning fabrics manufactured on the basis of high-quality materials, covered with an impregnation that constitutes a protective barrier and increases resistance to dirt.

2.3 PALLADIO AWNING CONSTRUCTION



2.4 TYPE OF BRACKETS

Wall bracket	Ceiling bracket	Roof rafter bracket
<p>205</p> <p>225</p>	<p>226</p> <p>240</p>	<p>406</p> <p>350 mm</p>

3 TRANSPORT AND STORAGE OF THE PRODUCT

3.1 COMPLETENESS AND QUALITY CONDITION OF DELIVERY

SELT Sp. z o. o. makes every effort to ensure that the goods comply with the order. However, checking the completeness of the product is the responsibility of the Buyer and should take place at the time of its receipt.

Any discrepancies should be immediately reported to the driver/warehouseman/assembly team and marked in the acceptance report or on the WZ document under pain of loss of claims in this respect. Checking the quality in terms of obvious defects is the responsibility of the Buyer and should take place at the time of receipt of the goods. Apparent defects are mechanical damage, scratches, cracks, etc.

Quantitative discrepancies and possible replacement of parts with obvious defects SELT Sp. z o. o. undertakes to supplement or replace it in the shortest possible time.

3.2 GENERAL CONDITIONS FOR TRANSPORT AND STORAGE OF THE PRODUCT

List:

- The product is factory-packaged in a cardboard box to protect it from damage during storage, transport and transport to the place of final assembly,
- products for transport/storage should be set in accordance with the arrows indicated on the product packaging,
- do not stack the products in more than two (2) layers because the packing material can be crushed, what in turn may lead to permanent damage to the product,
- products placed on means of transport should be protected against relocation and damage during the transport (e.g. with distance pieces, protecting belts etc.),
- during transport the product should be protected against rain or snow,
- storage locations should be dry, well-ventilated and protected against harmful impact of the weather (sun, rain, etc.),
- if product weight exceeds 25 kg its relocation to the final installation location should be carried out by at least two persons

3.3 OBLIGATORY DESCRIPTIONS TO BE PLACED ON THE PRODUCT PACKAGING



Prior to installation and use of the product please read carefully the operation and maintenance manual available at the following website: <https://www.selt.com/dte-en>

4 PRODUCT INSTALLATION

This chapter contains general requirements concerning the product installation.

Correct assembly is a necessary condition for smooth operation of the product. SELT Sp. o.o. recommends using only professional assembly crews, which guarantee the Purchaser that the conducted installation will be correct.

General requirements for safe installation

- it is necessary to observe general rules of good building practice,
- it is necessary to comply with applicable Occupational Health and Safety regulations concerning in particular those applying to the safety of operation of electrical equipment and work on heights,
- The product must be fixed mechanically (foams, adhesives or similar materials are not allowed as fixing materials).
- The product should be fixed to durable elements of the building (walls, lintels, steel structure, aluminum structure, window joinery).
- The base to which the wall and ceiling brackets of the product will be attached should be a solid structure (concrete, brick, etc.).
- Do not mount the product on elements that do not provide adequate load-bearing capacity.
- Installation is made to even, dry wall surfaces with appropriate strength, made in accordance with the general principles of building art.
- In the case of metal structures joined together in accordance with the applicable rules for joining metals, assembly is made to materials with appropriate wall thickness.
- Before starting the assembly, remove all unnecessary elements from the assembly area.
- Before starting the assembly, all mechanisms necessary for the operation of the drive should be immobilized.

Technical information

The manufacturer allows the installation of the product in the following types of substrate (wall bearing layer):

- reinforced or unreinforced concrete, class at least C20/25, non-cracked,
- concrete specified above having a layer of insulation with a thickness of up to 25 cm,
- wall at least 24 cm, of Mz solid bricks, NF format, with a strength of at least 20 MPa and a density of >1.8 kg/dm³ based on M2.5 - M9 mortar,
- wall at least 24 cm, of silicate blocks with a strength of at least 10 MPa and a density of >2 kg/dm³ based on M2.5 - M9 mortar
- wall at least 17.5 cm, of silicate perforated blocks with a strength of at least 20 MPa and a density of >1.4 kg/dm³ based on M2.5 - M9 mortar
- wooden (wall/ceiling) beams, class of at least C24, without cracks, with a thickness of at least 100 mm
- wooden rafters, class of at least C24, without cracks, with a thickness of at least 70 mm
- walls made of silicate blocks (full or hollow) with a layer of insulation – to be consulted with an authorised designer,
- solid brick walls with a layer of insulation - to be consulted with an authorised designer,
- wall made of cavity ceramic hollow bricks without insulation or with a layer of insulation - to be consulted with an authorised designer
- aerated concrete blocks - this substrate is not recommended.

The above list of substrates is only indicative. Each substrate suitability depends on the specific location and size of the product, and must be selected by an authorized constructor.

4.1 REQUIREMENTS FOR SAFE INSTALLATION OF THE PRODUCT AT HEIGHTS



Product installation, due to a necessity of execution of works on heights, is classified to the particularly hazardous works because it causes high risk of occurrence of threats for human health and safety - in particular in case of fall from heights.

Obligation to ensure preparation of occupational health and safety plan during installation should be fulfilled by the Purchaser. It is the Purchaser's responsibility to develop a health and safety plan during assembly. During assembly, the Purchaser should comply with the health and safety regulations related to work at height, in particular:

- direct supervision of execution by person appointed for this purpose (e.g. site manager, foreman),
- proper protection equipment, in particular equipment protecting against fall from heights,
- detailed guidance for employees working at heights,

- the need to use: ladders with appropriate quality and safety certificates, scaffolding, safety clamps, platforms with adequate resistance to the expected load.

Work at heights requiring the use of personal protective equipment against falls from a height must be carried out by at least 2 people.

4.2 PREPARATION FOR INSTALLATION

- unpack the product and check if there are all components necessary for assembling,
- prior to installation you should check whether the substrate has sufficient load capacity allowing safe assembly and operation,
- prepare a set of tools needed for self-assembly.

4.3 GENERAL REQUIREMENTS FOR SAFE INSTALLATION

- To avoid the risk of hand and fingers harm during opening and closing of the awning, the awning should be installed on such height so that the lowest element of the awning after it is opened is at least 2200mm above the ground,
- The product should be protected against any stains made by e.g. silicon, mortar or mounting foam, which may cause its damage,
- Using any chemical substances containing bituminous substances or any other substances making reactions with the product is forbidden,
- In case of installation in public places, e.g. hospitals, schools, boarding schools etc. The placement of switch/remote control device should be marked according to health and safety regulations,
- In case of remotely operated awning, bracket for remote control should be installed in place not available for children,
- Electrical installation, first programming of motor and specialized service can be conducted solely by specialized service companies.

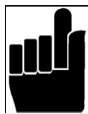

As a standard, the awning is packed in bubble wrap, in critical places protected with polyurethane foam in biodegradable foil, and the whole thing is packed in a multi-layer cardboard box in the position corresponding to the awning attached to the wall. The awning can only be transported in this way. Another form of transport may result in shifting the internal balance supports in the cassette and as a result in the appearance of dark lines along the seams of the fabric.



Improper installation may cause hazardous situation for the user.

4.4 INSTALLATION TOOLS

				drills hammer drill, ladder/scaffolding, screwdriver, hammer	measure tape, pencil/marker, spirit level, ring/flat wrenches, Allen keys, anchors.
--	--	--	--	--	--

4.5 INSTALLATION

Instructions for assembly, operation and safe use are available after logging in on website www.selt.com

4.5.1 PALLADIO AWNING INSTALLATION –WALL BRACKETS

SELT recommends the use of Fischer fixing products - selected depending on the type of substrate. Suggested recommendations for selected substrates:



- a) for non-cracked concrete class C20/25 and not higher than C50/60:

- M10x110 A4 anchors set on injection mortar (Fischer FIS A M10x110 A4 anchors on FIS V resin or an equivalent product from another manufacturer is recommended)
 - Insertion depth in concrete 80 mm
 - Distance from anchor axis to base edge: min. 45 mm in case of M10 anchor
 - Minimum base thickness is 150 mm for M10 anchor
- b) for Porotherm wall with insulation max. 15 cm:**
- Thermax 16/170 M12 anchors with 20x200 sleeve mesh, embedded in injection mortar (Fischer FIS V resin)
- c) for walls with solid brick or concrete with insulation max. 15 cm:**
- hermax 16/170 M12 anchors embedded in injection mortar (Fischer FIS V resin)

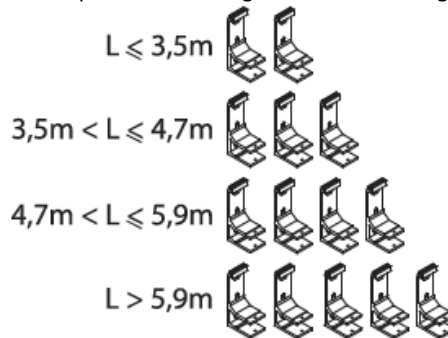
The required number of wall brackets depends on the length "L" of the awning:

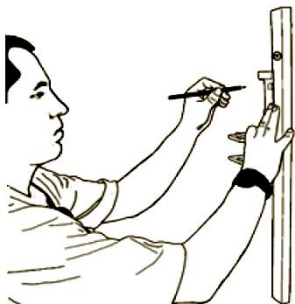

It is recommended to mount the outer wall brackets at a distance of 20 to 45 cm from the ends of the awning, and place the remaining brackets at equal intervals.

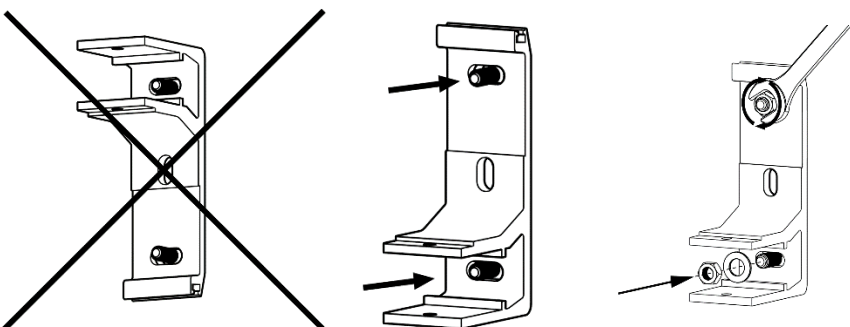
<p>1) Prepare installation tools according to the list.</p> 	<p>2) Start the installation with marking installation spots for wall brackets. Level the bracket vertically with spirit level and mark places for installation holes.</p> 	<p>3) Drill holes in the marked places.</p> 	<p>4) Fix installation anchors.</p> 
<p>5) Screw the wall bracket in the position as shown in the drawing in the available variants using: the upper and lower holes. Follow the anchor manufacturer's instructions regarding required anchor spacing, preparation and installation method.</p> 			

6) Based on the first installed bracket (base) mark installation places for remaining ones – pay particular attention so that brackets are installed at the same horizontal level and in the same plane.



7) Drill holes in marked places.

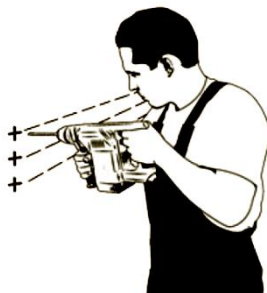

8) Fix installation anchors.



9) Install remaining wall brackets.

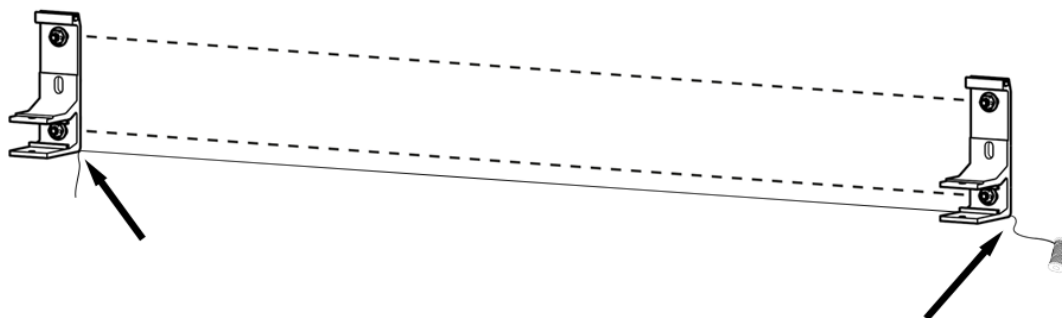

10) Slide the awning (cassette) on wall brackets so that the construction is maximally pressed to the back (Note – before placing the awning verify the alignment of brackets – wall surface should be of the same thickness at installation spots).



11) Secure square bar with M8x65 screws and put PVC cover on them.

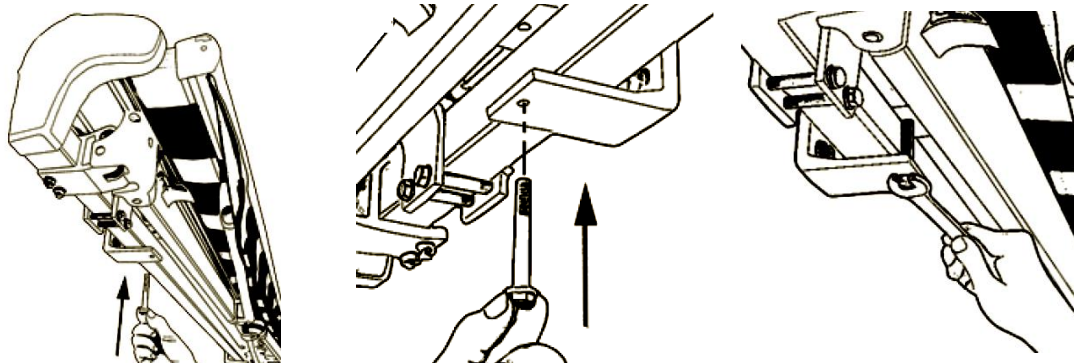

12) Open the awning slightly.



13) If necessary adjust the arm level by loosening or tightening the internal M5 screw in arm brackets.



14) With spirit level check if the arms close to one plane.

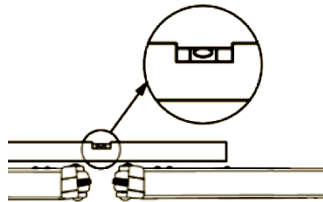

15) Open the awning completely.



16) To change the tilt angle of the awning use an Allen wrench to loosen (increase the tilt angle) or tighten (decrease the tilt angle) adjusting screws (with button-heads) of the arm brackets.

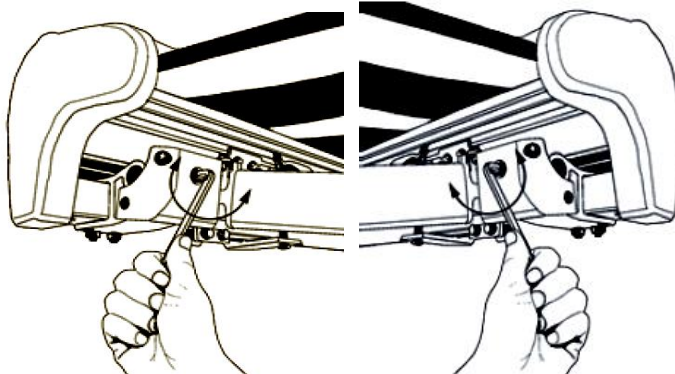

17) With spirit level check if front bar is levelled horizontally.

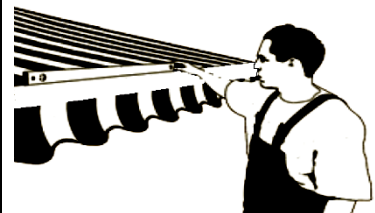

4.5.2 PALLADIO AWNING INSTALLATION – CEILING BRACKET

- Brackets should be installed in the same order and manner as wall brackets.
- It is recommended to install the extreme ceiling brackets at a distance of 20 to 45 cm from the ends of the awning, the remaining ones should be placed at equal intervals.
- Make sure that ceiling brackets are aligned, i.e. in the same distance from the wall.
- To the installed ceiling brackets install wall brackets with set of M10x35 screws with washers and nuts. Slide the awning on wall brackets so that the construction is maximally pressed to the back.
- Secure square bar with M8x65 screws and put PVC cover on them.

4.5.3 PALLADIO AWNING INSTALLATION – ROOF RAFTER BRACKET

- Roof rafter brackets should be installed to roof rafters the closest to awning edge possible (it is recommended to install them at a distance of 20 to 45 cm from the ends of the awning), remaining brackets place in equal intervals.
- Brackets should be installed in the same order and manner as wall brackets.
- Secure the roof rafter bracket using scrws for wood or bolts.
- Based on the first installed roof rafter bracket (base), mark the places where the remaining roof brackets will be installed - pay special attention that the mounted roof rafter brackets are in one line, i.e. at the same distance from the end of the rafters.
- Remember to install left and right roof rafter bracket alternatively, i.e. starting from awning right edge (looking at the awning from the front).
- To the installed roof rafter brackets install wall brackets with set of M10x35 screws with washers and nuts. Slide the awning on wall brackets so that the construction is maximally pressed to the back. Secure square bar with M8x65 screws and put PVC cover on them.

4.6 ELECTRIC DRIVE

The installation must be performed by an electrician possessing appropriate permissions and professional experience. The connection should be made in accordance with the previously elaborated, individual electric diagram and according to the motor manual. There is a possibility of individual and group control with one or multi channel remote control. Transmitters and receivers should be programmed according to the instructions attached to the motor. When the awning starts working special attention should be paid to correct rolling up and down of the fabric and proper functioning of limit switches in the motor.

List of steps:

- connection to the electrical supply system,
- connection to the electrical control system.

4.6.1 CONNECTION TO ELECTRICAL INSTALLATION

After the product is installed one may proceed to connecting the drive and control system to the previously prepared systems: power supply and control systems. Connection to the power supply system should be made in accordance with the previously elaborated individual electric diagram, including fire protection regulations.

The connection must take into account the environmental conditions in which the product will be used. The connection must be made by a licensed electrician.

The electrical connection and setting of the motors must be carried out in accordance with the instructions of the motor manufacturers.

The instructions are attached to the product and are also available on the websites of motor manufacturers and on the website:

www.selt.com → OUR OFFER → MOTOR, ELECTRIC, EQUIPMENT

Environmental conditions with increased risk:

environments with increased risk include bathrooms and showers, kitchens, garages, cellars, saunas, rooms for pets, operating blocks of hospitals, hydrophores, heat exchangers, spaces limited by conductive surfaces, campsites, open areas, etc.

In rooms and spaces with increased risk conditions, automatic devices should be used to turn off the power supply to the damaged product, e.g. residual current devices. It is recommended to use in bathrooms, kitchens, garages and basements. Must be used in swimming and shower pools, saunas, on construction sites, when powering outdoor devices, in farms and horticulture, in camping and recreational vehicles and in rooms at risk of fire.

Residual current devices are only supplementary protection from direct contact, they cannot be the only means of protection. The goal of their application is to supplement the protection in case other means of protection from direct fail or in case of user's carelessness.

During installation attention should be paid to usage safety rules, e.g. minimum height electrical appliances can be installed at.

General guidelines for safe connection:

- The connection must be performed by electrician possessing appropriate permissions and experience,
- During connection health and safety regulations should be observed,
- Electrical connection and adjustment of motors should be performed according to the motor manufacturer's manual added to the product
- pay attention to the correct position of the power cable at the entrance to the product so that the water may be drained and flow down the cable.



Incorrect connection of the motor can lead to product damage or create a hazardous situation.



The motors have thermal switches that turn off the drive after a few minutes of continuous operation to protect against overheating. After switching off by the thermal protection, wait an appropriate time depending on the type of motor and ambient temperature (several minutes) to be able to restart it.

4.6.2 REMOTE OPERATION

Remote operation programming (assigning remote control appliances, weather sensors and other operation elements) should be performed according to the manufacturer's manual added to the product. The method of using the motors is included in a separate instruction manual, as well as on the manufacturer's website.



The product may be damaged if the central control does not function properly.

An interruption in the power supply or a failure of the installation may cause the central control to malfunction.

Awning motors are not designed for continuous operation. The integrated overheating protection shuts down the motor after a few minutes of continuous operation. The motor restarts after several minutes. This is the time it takes for the motor to cool down. This time depends on the ambient temperature.

4.6.3 START-UP AND ADJUSTMENT

Recommendations and actions:

- extreme position (up and down movement of the fabric) are protected by limit switches that needs to be adjusted during the installation,
- person performing the adjustment of extreme positions should possess adequate electrical permissions, knowledge and experience,
- adjustment of limit switches must be done in accordance with motor's maintenance manual,
- prior to the first start of the product electrical measurements should be performed by person holding adequate permissions,
- do not start the motor without checking the correctness of system installation,
- after the awning is put into motion with a switch do not take off the casings, end covers, lean on the product, leave tools on it,
- the effectiveness of zeroing the product and the electrical system should be checked at each new installation site.

When the awning starts working attention should be paid to:

- Correct rolling down and up of the fabric
- Correct activation of limit switches



Self-regulation of extreme position by an untrained person may lead to product damage.

4.7 MANUAL DRIVE

Awning opening is performed by making enough turns with the crank until the arms are opened, keeping the fabric tension.

Awning closure – by turning the crank until gentle resistance is felt.

Gears 11:1 are not equipped with overturn protection (so called mechanical end stop).

During operation of awning with manual drive the force working on the crank is multiplied by gear mechanism and putting too much force can lead to fabric damage, especially when closing the awning.

Do not allow the fabric to be rolled in the opposite direction (from the bottom of roller tube), since it may cause its ripping off the roller tube, fabric damage or incorrect awning functioning.



Do not allow the fabric to be rolled in the opposite direction (from the bottom of roller tube), since it may cause its ripping off the roller tube, fabric damage or incorrect awning functioning.

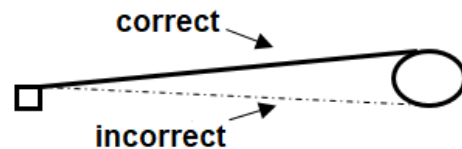

5 SYSTEM OPERATION AND PRODUCT SAFETY

5.1 GENERAL REQUIREMENTS FOR OCCUPATIONAL HEALTH AND SAFETY

- During transport, assembly and disassembly and during servicing and maintenance of the product you should observe applicable occupational health and safety regulations and environmental protection rules.
- The product should be maintained and repaired only by a trained person with proper authorizations.
- Product purchaser should ensure that person, which are entrusted with the operations related to the routine operation, maintenance and hygiene have been familiarized with the user's manual and are observing all guidelines contained in this manual.
- It is forbidden to clean the product in the other way than described in the point "Technical inspections, maintenance and repair."
- All work must be carried out with due diligence, taking into account safety requirements.
- Maintenance works and repair of the product should be carried out only when the product is disconnected from the electrical power supply.
- Observe marking on the product (e.g. pictograms, arrows for movement direction).
- Pay attention not to cover the marking with a coat of paint or damaged in a way that prevents its reading.
- Without consulting the manufacturer or an authorized representative, it is not allowed to modify the electrical design or change the configuration of the equipment.
- Please read this documentation carefully before using the product.
- The switch should be installed on a height conforming the national regulations applying to disabled people - preferably at height min. 130 cm.
- In the event of strong wind (exceeding the declared wind class) or heavy rain, the product should be rolled up immediately - otherwise it will lead to permanent damage
- It is recommended that the change of equipment configuration be consulted with SELT.

5.2 SAFETY REQUIREMENTS RELATED TO SPECIAL CONDITIONS AND PLACES OF PRODUCT USE

Specific safety requirements relate to children up to 42 months. Essential requirements for use are applicable in all locations, to which children have access or where they could be present. Specific requirements for operation are applicable also in all locations where the disabled people stay.



Prior operation the Purchaser should carry out an individual risk assessment for the operation of the product with special attention paid to the safety of children and disabled people.

When determining the operational requirements of the product, it is important to take into account reasonably foreseeable conditions of use and potential hazards.



Do not allow children to play with the roof controls. Remote control equipment should be kept away from children.



Often inspect the system with respect to the signs of wear and tear or cable damages. Do not use the product if repair is necessary.

5.3 OPERATIONAL SAFETY



The product may only be used if there are no faults.

Recommendations and actions:

- Product is safe providing use in accordance with the recommendations included in this documentation.
- Disconnect the product from the power supply before starting any work not related to the maintenance and service of the product, performed on the facade of the building.
- All works related to inspections and repair of the product should be carried out by a properly trained person holding the necessary licenses.

- pay attention to all signs of wear and tear or damage to the electrical cables.
- If you notice signs of wear or damage to the electrical wires, do not use the product and immediately report the fault to the supplier.
- Keep remote controls out of the reach of children.
- When extending or folding the arms of the product, pay special attention that no object or person is in the working area of the product (in the space between the roller tube and the front bar).
- Avoid contact of the awning fabric with hot objects (e.g. heaters, stoves, irons, etc.)
- It is recommended to use motors with wind automatics that close the awning in case of gusts of wind, but it should be remembered that wind automatics will never protect the awning against the risk of damage from violent gusts of wind exceeding the "closing" settings.

Forbidden actions

- It is not allowed to hold or hang or attach anything to the awning. This may damage the system!
- Keep out of the working area of the arms and fabric while the system is operating.
- It is forbidden to use the product inconsistent with the requirements of electric shock and fire safety.
- It is forbidden to exceed the operating parameters of the product specified in the technical and operational documentation.
- It is forbidden to store sharp objects or protruding parts near the system, which may catch on the front bar, arms or awning fabric.
- It is forbidden to use a faulty or incomplete product (e.g. without a switch, etc.). the use of such a product may cause its destruction, pose a threat to the health and life of the user.
- It is forbidden to make makeshift repairs.
- It is forbidden to use the product and electrical installation without valid and required inspections and measurements.
- It is forbidden to remove the covers of the drive system and the electric motor.
- Do not touch moving parts when rolling or unrolling. This may cause crushing, cutting, pulling in, wedging between e.g. the front bar and the arm or other structural elements of the system.
- There should be no obstacles within the system operation that could interfere with its operation or cause its damage.
- Do not stay in the movement zone of the product during its operation.
- Do not expose the awning fabric to prolonged moisture.

Automatically controlled products may start up on their own. Make sure that no dangerous situation arises.

SELT Sp. z o. o. is not responsible for damage caused by improper use.



Operating the system out of sight can cause serious injury as well as damage to the system

WARNING !



Do not use the product in the event of strong gusts of wind, during snowfall, freezing rain because the product may be destroyed or damaged and may endanger people in the vicinity (applies to products installed outside the building).

STARTING THE PRODUCT IN FROST CONDITIONS MAY DAMAGE THE PRODUCT

In the event of any irregularities in the operation of the product, the Supplier of the product should be immediately notified. The use of a damaged product and attempts to repair it yourself pose a threat to health and life and may void the warranty.

5.4 CONTROL OF SAFE USE OF THE PRODUCT**The Buyer should:**

- a) where the safe use of the product depends on the conditions in which it is installed, submit the product to:
 - initial inspection (after its installation and before it is put into operation for the first time),
 - inspection when installed elsewhere.

- b) ensure that the product exposed to conditions causing deterioration of its technical condition, which may result in dangerous situations, is subjected to:
 - periodic inspections and tests,
 - special control in case of possible product-related safety deterioration and as a result of:
 - modification works,
 - natural phenomena,
 - extended rest time,
 - dangerous damage and accidents at work.

The above-mentioned checks may be carried out by specialized assembly groups with appropriate qualifications.

6 SYSTEM USE AND MAINTENANCE

6.1 USING THE PRODUCT IN ACCORDANCE WITH ITS INTENDED USE

The system should be used in accordance with its intended use specified by the manufacturer. If the product is used and modified in a manner other than described in this documentation, then it is used incorrectly.

Unauthorized changes affecting the operational safety of the product are not allowed.

The correct use of the product includes:

- normal use or foreseeable use, which do not include e.g. risk taken by the user intentionally or deliberately,
- use of allowable values of operation parameters,
- compliance with recommendations related to the operation,
- conducting periodical inspections and maintenance of the product,
- compliance with the requirements set out in the section "Control of safe use of the product,"
- compliance with the requirements specified in point "Technical specification."

In case of misuse:

- the product may endanger the operating personnel
- the product will be exposed to damages
- this may adversely affect its functionality
- Do not use the product during maintenance work (e.g. cleaning windows).

SELT Sp. z o.o. shall not be responsible for damages caused by misuse.

6.2 INSTRUCTION FOR NON-PROFESSIONALS

Read carefully this document before using the product.

Non-professionals are persons who carry out activities related to the current use and current inspections of the product. In-depth knowledge of the documentation ensures failure-free operation of the product.

List of operations which can be carried out by non-professionals:

- current use:
 - performing activities that do not affect the change of the product's operating parameters,
 - switching on and off by pressing the control buttons,
- maintenance of the product is described in the further part of the documentation.

6.3 TECHNICAL INSPECTIONS, MAINTENANCE AND REPAIR

It is recommended to carry out periodic inspections of products by specialized assembly teams.

Inspections consist in checking the operation of the product, adjusting mechanisms and replacing elements that wear out during its operation. The current maintenance of the system is carried out by the user on their own. Product maintenance should be performed at least once a year by specialized assembly teams.

Inspections are performed for a fee.

Basic activities performed during the inspection:

- Checking:
 - fixing of the product to structural elements,
 - the technical condition of the moving parts of the product,
 - the condition of the product's electrical wires and checking their connection to the electrical system,
 - bolt and rivet connections,
 - the technical condition of the fabric and gaskets,
 - the fastening of the drive mechanism of the product (engine, crank gear),
 - the effectiveness of the residual current circuit breaker.

Possible adjustment and improvement of fastening of the mentioned components.

Products manufactured by SELT Sp. z o. o. do not require any special maintenance. Using the product in accordance with the manufacturer's instructions ensures long-term and trouble-free operation for the system user. Ongoing maintenance work should be carried out on a fully developed system.

Basic activities including product maintenance:

- Checking the correct unrolling and rolling of the awning fabric,
- Checking the condition of the fabric,
- Cleaning the fabric,
- Checking the correct operation of the limit switches,
- Cleaning visible, accessible elements of the product.

Cleaning of metal / aluminium elements:

- It is recommended to clean lightly soiled metal / aluminum surfaces with water with the addition of mild detergents.

Cleaning the fabric:

- Unroll the fabric completely,
- Impurities can be removed by gently brushing or vacuuming the surface of the fabric,
- Cleaning the fabric only with clean water or a mild solution of water and soap (maximum water temperature 30°C),
- Do not use any solvents or strong detergents to clean the fabric,
- After using a mild solution, rinse the fabric thoroughly with clean water,
- Dry the fabric thoroughly before rolling up the awning.

Activities prohibited during product maintenance:

- It is forbidden to use a pressure washer, as well as cleaning agents, sponges and solvents (e.g. alcohol, petrol).
- It is forbidden to use cleaning agents containing chlorine, ammonia, kerosene, acetone and bleach to clean the system or in its vicinity, as this will cause the risk of corrosion.
- It is forbidden to use sharp tools (e.g. wire brushes), cleaning agents that cause scratches (e.g. scouring powders, pastes).
- Do not hold or pull the system or its individual components firmly.
- Do not replace damaged elements with substitutes! Spare parts should be original!
- Water must not be allowed to enter the motor.
- It is necessary to make a test operation of the system. Pay attention to the operation of the system, and in the event of unusual behavior and noises, report the problem to the direct supplier.

6.4 USE OF AWNING FABRICS

Only first-class fabrics are used for the production of awnings. With the most modern machines at our disposal, even with the current state of technology, some changes in the fabric cannot be avoided:

- Due to the fact that the fabric at the seams is double folded, the diameter of the roller tube with the fabric varies in different places. Arising tensions will result in appearance of so called "embossing" or "waving" effect near the seams (1, 2, 3), in the middle of the fabric or along the edges (4).
- Another change in the fabric appearance are creases that could appear while the textile is rolled up. In the area of creases a delicate line could be visible in certain light (1,2,3). It mainly applies to dark-colored textiles.
- Side strips are particularly exposed to heavy load, therefore a slight drop of the edges may occur (5).
- The acrylic material is coated with fluororesine, which, in addition to giving the fabric well-known technical properties, makes it stiffer. This is a necessary requirement considering the scope of its application. This property may result in the formation of micro-clearances near folds, wrinkles or damage to the fabric.
- Due to the use of an impregnating agent, the fabric is sensitive to all kinds of scratches that are difficult to avoid even with a very precise and careful production process. This effect applies primarily to monochromatic materials.

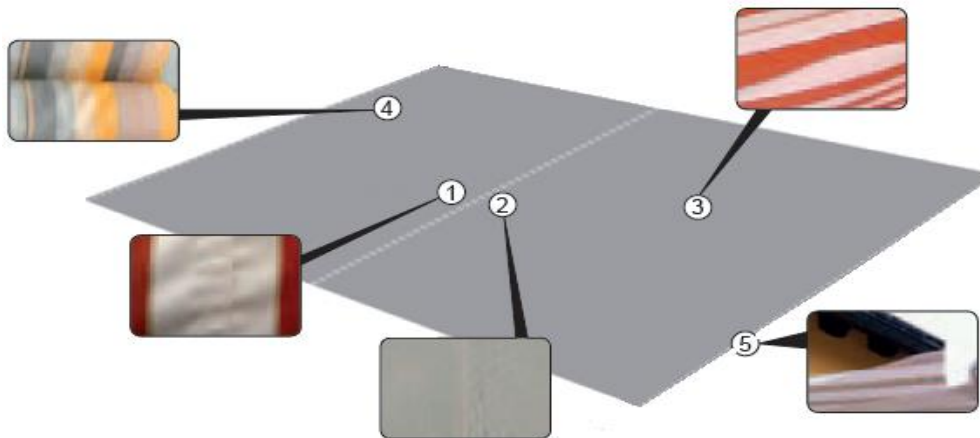

All of the above described changes cannot be the basis for complaints, because they are typical for awning fabrics and do not influence the comfort of use.

Do not unroll the awning during heavy rainfall and expose the fabric to long-term moisture, even if the attached fabric has the features of a fabric with increased water resistance or is made of PVC material.

Stagnation of water on its surface may lead to overloading of fastenings and to slight deformations and waviness of the fabric surface. If the damp fabric is rolled up, unroll it immediately after the rain stops and let it dry.

7 GENERAL WARRANTY TERMS

General warranty terms are available on www.selt.com

If the SELT Sp. z o.o. website is inaccessible then warranty terms and conditions can be obtained from the sales representative of SELT Sp. z o.o.

7.1 WARRANTY EXCLUSIONS

The warranty will not cover:

- Damages caused as a result of other transport than the SELT's transport.
- Damages resulting from storage, installation or maintenance incompatible with the operation and maintenance manual, user's manual or Supplier recommendations, unless they are executed by the Supplier.
- Damage caused as a result of use not in accordance with the technical and operational documentation or the Supplier's recommendations.
- Mechanical damage.
- Damage resulting from the modification of the equipment, unless the modification was made by the Supplier, on his order or with his written consent.
- Secondary damage resulting from the use of the device despite the original defect being noticed, unless the Supplier has been notified and recommended further use. The assessment of the causes of damage shall be left to the reasonable discretion of the Supplier. Repair or replacement of the device due to damage referred to in this point may be carried out by the Supplier against payment.
- Defects resulting from normal wear and tear of product parts, such as gaskets, lubricants, etc.
- Repairs consisting in adjustment, cleaning and lubrication.
- The effects of using motors with mechanical end stops for cassette awnings. For cassette awnings, it is recommended to use motors with electronically set limit switches that reduce the effects of folding, edge lengthening, sagging of the fabric. By choosing motors with mechanical limit switches for this type of awning, the ordering party consciously accepts the multiplied effects of fabric deformation (awning cover).
- Electrical equipment that has been handed over to the Supplier in a way that makes it impossible to check its operation (e.g. motor cable cut, receiver disassembled).
- Electrical damage caused by the fault of the user.
- Damage caused by: improper installation of the product, unauthorized repair or adjustment
- Damage caused by using the system in inappropriate weather conditions.
- Operating the system despite component damage
- Damages cause by atmospheric and phytosanitary pollution and dirt caused by animals.
- Unsymmetrical rolling of the fabric on the roller tube caused by thickening and impurities on the fabric surface (e.g. leaves, mud, etc.)
- Damage caused by using the system in inappropriate weather conditions. Damage, destruction of the awning and cover caused by wind and precipitation, such as rain, hail, snow and ice.
- Use of the product at an ambient temperature of 0°C and below 0°Celsius.
- So-called jumping effect, i.e. a slight axial deviation of the roller tube when opening or closing the awning, which is associated with a slight deflection of the roller tube and inserted into the pocket PVC profile fixing the fabric in the roller tube. This effect does not affect the correct operation of the system.
- Gentle falling of the cover on the joints of the arms when the awning is not fully opened. The degree of this effect depends on the model of the awning, in particular on the arm length and width. It does not affect the correct operation of the system.
- Damage resulting from the use of a smaller number of mounting brackets than provided by the Manufacturer.
- The effect of horizontal deformation of the front bar up to 25 mm with the width of the awning close to the maximum. This is a natural physical phenomenon caused by the beam being supported only at the ends and being affected by the stretched fabric. This effect does not affect the correct operation of the system.

Warranty for the fabric will not cover:

- Horizontal creases on fabrics, which are caused by the PVC profile inserted into the pocket that fastens the fabric in the roller tube.
- For awning fabrics the phenomena described in the section "Use of awning fabrics."

Selection of electric motors:

Drive selection for awnings		DRIVE FEATURES										AWNINGS												
DRIVE	NAME	GROUP	ELECTRIC DRIVE FEATURES						BALCONY		TERRACE			CASSETTE			SIDE SCREEN BORA							
			Mechanical limit switches	Parallel connection to a control system	LOWER electronic limit switch Standard	UPPER electronic limit switch Standard / Automatic	Torque reduction permitting gentle closure of the cassette	Emergency manual override	Built-in control unit	Possibility of wired control by switch	Feedback signal confirmation	ITALIA BALCONY	ITALIA BOX	MALTA	SILVER PLUS	AUSTRALIA		JAMAICA	PALLADIO	CORSICA	DMAR	CASABLANCA		
CRANK	Gear 11:1																							
	To control with switch or wired or radio receiver	RED		⊘																				
		YELLOW		⊘																				
		RED		⊘																				
		YELLOW		⊘																				
		BLUE		✓		✓																		
	MOTOR 230V~	YELLOW		✓		✓																		
		RED				✓																		
		BLUE				✓																		
		YELLOW				✓																		
		YELLOW				✓																		
RED					✓																			
To control with remote control dedicated for given motor	RED				✓																			
	YELLOW				✓																			
	YELLOW				✓																			
	YELLOW				✓																			
	RED				✓																			
MOTOR 12VDC	AXIS-H		✓																					

✓ drive has a particular feature
+++ drive recommended especially for the particular awning, torque reduction allows for gentle closure of the cassette
++ drive recommended for a particular awning
+ use of motor is possible, but not recommended for awnings with small dimensions (motor has overloaded limit stop only)
~ motors with mechanical limit switches cannot be connected in parallel through the same contact switch or controller
⊘ Overload limit stop only
- use of this drive in the awning is not possible or it is recommended to use different motor
+ use of the motor is possible without the crank

8 COMPLAINT / TECHNICAL DEFECTS

8.1 COMPLAINTS (MANUFACTURER'S WARRANTY)

Complaints can only be made by the entity that purchased the product from the manufacturer.

The terms and way of handling complaints are defined in the General Guarantee Terms and Conditions as well as the General Sales Terms and Conditions.

The General Guarantee Terms and Conditions and the General Sales Terms and Conditions are available on the website: www.selt.com.

The Customer submits a complaint on the Complaint form available on the manufacturer's B2B platform. The complaint notification should be full and complete.

A complaint submitted in a different way than via the B2B Platform, which is incomplete or partial, without given invoice number, order number or contract number, will not be considered.

8.2 TECHNICAL DEFECTS

In case of system defects you should:

- Roll up the blind and put it out of use.
- Immediately report a product defect to the Seller.
- Notifications can be sent to the e-mail address reklamacje@selt.com or directly to a sales representative.

Reporting a technical defect / complaint should be made in writing on the "complaint notification" form, which can be found at www.selt.com or directly to the sales representative.

9 PRODUCT DISASSEMBLY / UTILISATION / DISPOSAL



Improper disassembly of the system can cause serious personal injury and damage the system. Disassembly of the system should be entrusted to a properly specialized assembly team or a person with appropriate health and safety training and knowledge in the field of recovery.

a) Disposal of waste electrical and electronic equipment

After the end of the product's life, in order to dispose of it, it is necessary to dismantle it and segregate individual materials and elements in accordance with the Regulation of the Minister of Climate of December 9th, 2014 on the waste catalog – Dz. U [Journal of Laws] 2014, item 1923.

Important disposal information:



In compliance with the Act of 11 September, 2015 on waste electrical and electronic equipment it is forbidden to place the waste equipment marked with the crossed bin symbol with other waste to a container intended for the domestic waste. The user, wanting to dispose of electronic or electrical equipment, is obliged to return it to a waste equipment collection point.

The above statutory obligations were introduced in order to limit the amount of waste generated from waste electrical and electronic equipment and to ensure an appropriate level of collection, recovery and recycling. The equipment does not contain hazardous components which have a particularly adverse effect on the environment or human health.

No.	Subject	European Legal Basis	Polish Legal Basis
1	Waste Electrical and Electronic Equipment	Directive 2012/19/EU of the European Parliament and of the Council of 4 July 2012 on waste electrical and electronic equipment (WEEE)	Act of September 11, 2015 on waste electrical and electronic equipment (Journal of Laws of 2020, item 1893)
2	Waste catalogue	Commission Regulation (EC) No. 574/2004 of 23 February 2004 amending Annexes I and III to Regulation (EC) No. 2150/2002 of the European Parliament and of the Council on waste statistics	Regulation of the Minister of Climate of December 9, 2014 on the catalog of waste (Dz. U. [Journal of Laws] 2014, item 1923)

b) Utilization of used batteries

In compliance with provisions of the Act of 24 April 2009 on batteries and accumulators the **End User** is obliged to transfer used portable batteries, which are no longer used as a source of energy, to a **collector** or to collecting point. It is forbidden to place use batteries with the other waste in the same container.

To prevent environmental pollution and causing a possible hazard for human and animals health, the used battery should be discarded to the proper container in the designated collection points.

No.	Subject	European Legal Basis	Polish Legal Basis
1	Used batteries and accumulators	Directive 2006/66/EC of the European Parliament and of the Council of 6 September 2006 on batteries and accumulators and waste batteries and accumulators and repealing Directive 91/157/EEC	The Act of 24 April 2009 on batteries and accumulators (Dz. U. [Journal of Laws] 2009, no 79, item 666)

10 MARKING AND LABELLING OF THE PRODUCT WITH CE MARK

10.1 PRODUCT COMPLIANCE WITH THE CE STANDARD

Products manufactured by SELT company meet the essential requirements of the standard introduced by the Polish Committee for Standardization as PN-EN 13561 what is confirmed by the manufacturer's declaration of performance and marking the product with the CE mark.

To maintain this condition and to ensure safe use and maintenance of the system, the installation, operation and safe use instructions must be followed.

10.2 INFORMATION ACCOMPANYING THE CE MARKING

a) Marking on the product:

SELT Sp. z o. o. Opole, ul. Wschodnia 23A
EN 13561

SELT Sp. z o. o. Opole, ul. Wschodnia 23A
2006/42/EC

b) Marking on accompanying documents:

				
SELT Sp. z o. o. Opole, ul. Wschodnia 23A POLAND 07				
EN 13561 Awning with folding arms for external, operated manually or with electric motor, intended for buildings. PALLADIO.700x160-210-260-310-360 DWU 05/M/2018				
Essential characteristics			Performance	Harmonised technical specification EN 13561:2015
Resistance to wind load			Class* (pressure)	
Width [cm]	Projection [cm]	Number of arms		
up to 700	up to 260	2 or 3	2 (84 Pa)	
up to 590	310 or 360	2	1 (48 Pa)	
above 590 up to 700	310	3	2 (84 Pa)	
above 590 up to 700	360	2	0 (<48 Pa)	
above 650 up to 700	360	3	1 (48 Pa)	
Total solar Energy transmittance g_{tot}			0,01-0,90**	

*-According to EN13561:the maximum class for the awnings with folding arms is class two.

**-external sun protection system together with type C glazing according to EN14501:2005; detailed data depending on the fabric model are given in tables on the manufacturer's website



SELT Sp. z o. o.
Opole, ul. Wschodnia 23A
POLAND
07

Awning with folding arms
PALLADIO
230V/ 50 Hz
Power 198 to 275 W
01 / DZ/2017